

9E: Wood Exterior Posts and Gingerbread

Pricing at store.bbwood.com



Pg 5



HBG



HBG



HBG



Pg 2-3



Page 7 porch spandrel



Page 7

Table Contents	Pages
Balusters & Newels: Wood	2-3
Columns: Round Wood	4
Columns: Round Fiberglass	HBG
Columns: Square Fiberglass	HBG
Columns: Aluminum	HBG
Pergola, Arbor, Trellis	HBG
Porch Posts: Wood	5
Porch & Lamp Posts - Synthetic	HBG
Porch Systems: Synthetic	HBG
Lally-Basement Pole Covers	6
Victorian Gingerbread	7



Post Tops: Page 2

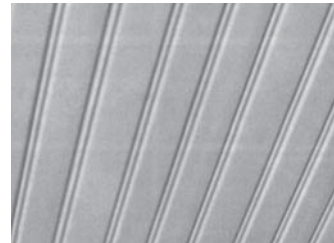

Porch Ceiling - HBG

Fiberglass Columns & Porch: see HBG

B&B Wood Products inc.

Exterior Wood Porch System

Parts are kiln-dried softwood and ready to paint. Rail is fingerjointed. Order top rail fillet separately. Newels are laminated. See option for balusters and newels dip-treated with "Wood-Life". Top and bottom of balusters, bottom of newels and ends of rail must be sealed (primer is not a seal) after cutting to size and BEFORE installation. If staining use a minimum of three coats of polyurethane or marine varnish.

Balusters	H-Series	Size	Turning Length
	H207	1-5/8" x 7.5"	4-7/8"
	H212	1-5/8" x 12"	
	H218	1-5/8" x 18"	8-1/4"
	H224	1-5/8" x 24"	
	H232	1-5/8" x 32"	14-3/4"
	H236	1-5/8" x 36"	
	H312	2-5/16" x 12"	8-1/4"
	H318	2-5/16" x 18"	
	H324	2-5/16" x 24"	
	H332	2-5/16" x 32"	14-3/4"
	H336	2-5/16" x 36"	
	H412	3-1/4" x 12"	8-1/4"
	H418	3-1/4" x 18"	
	H424	3-1/4" x 24"	
	H432	3-1/4" x 32"	14-3/4"
	H436	3-1/4" x 36"	

Newels

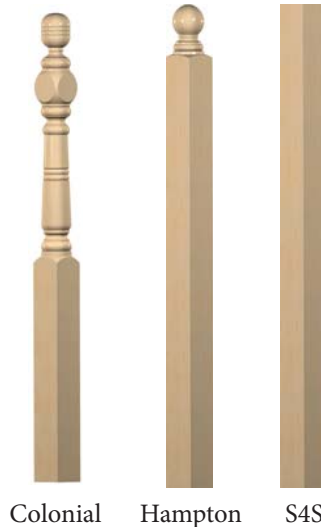

Item #	Colonial (CL)
460CL	3-1/4" x 3-1/4" x 60"
560CL	4-1/4" x 4-1/4" x 60"
Item #	Hampton (HN)
560HN	4-1/4" x 4-1/4" x 60"
Item #	S4S
560S4S	4-1/4" x 4-1/4" x 60"



Top Rail	
HT2 1-5/8" Plow : 1-1/4" x 2-1/2"	HT3 2-5/16" Plow : 1-1/4" x 3-1/2"
Fillet	
HF2 1/4" x 1-5/8"	HF3 1/4" x 2-5/16"
Exterior Bottom	
HB2 1-1/8" x 2-5/8"	HB3 1-1/8" x 3-1/4"

Item #	Description
HT2	Top rail 2-1/2"
HF2	Fillet for HT2 rail
HB2	Bottom rail 2-5/8"
HT3	Top rail 3-1/2"
HF3	Fillet for HT3 rail
HB3	Bottom rail 3-1/4"

Exterior Paint Grade Wood Post Tops

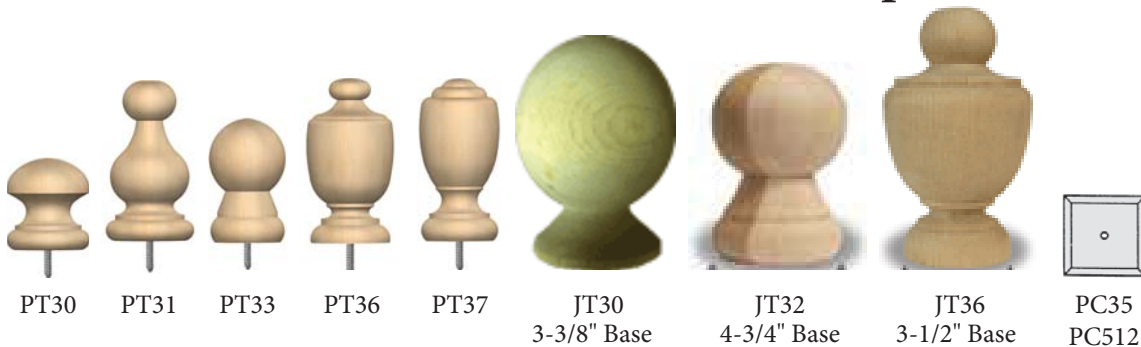

ITEM	Width	Height
JT30	4-1/2"	6"
JT32	5"	7"
JT36	4-3/4"	8"
PT30	2-3/4"	3-3/8"
PT31	2-3/4"	5-7/8"
PT33	2-3/4"	4-1/2"
PT36	2-3/4"	6"
PT37	2-3/4"	6"
PC35	4-1/4"	
PC512	5-1/2"	

Custom Exterior Wood Balusters

Choose a design listed below or send us a picture and we can turn it into your "dream porch". We can manufacture balusters in any wood specie. All of our balusters can be treated with "Wood-Life" preservative as an option. To extend the life of your wood balusters please finish them after cutting to size and before installation. We recommend using wood balusters with our urethane top and bottom rails shown on page 31 and at the bottom of this page.

Promenade Baluster Series

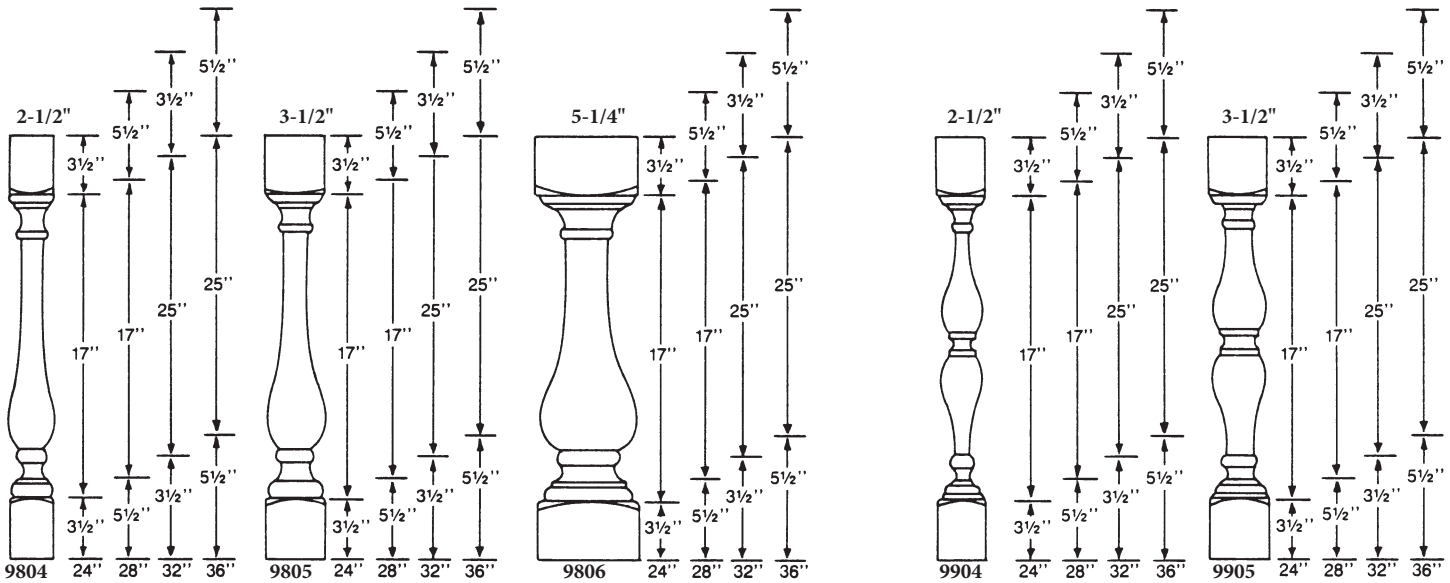

More Custom Design Ideas

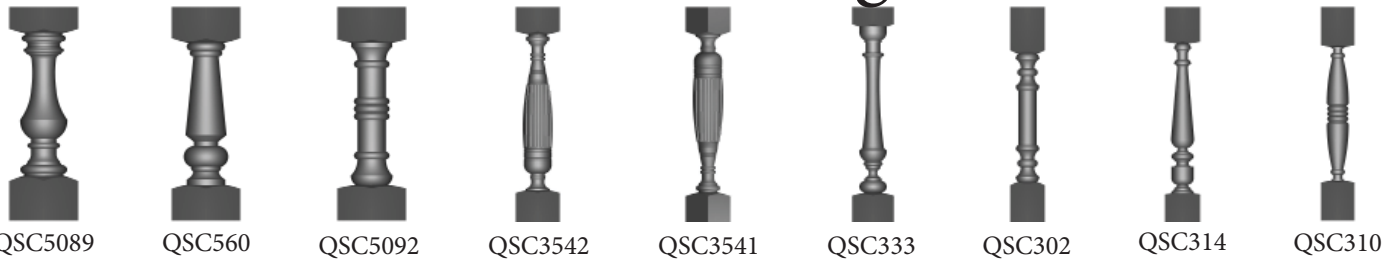

Urethane Top and Bottom Rails - 8', 10' & 12' Lengths

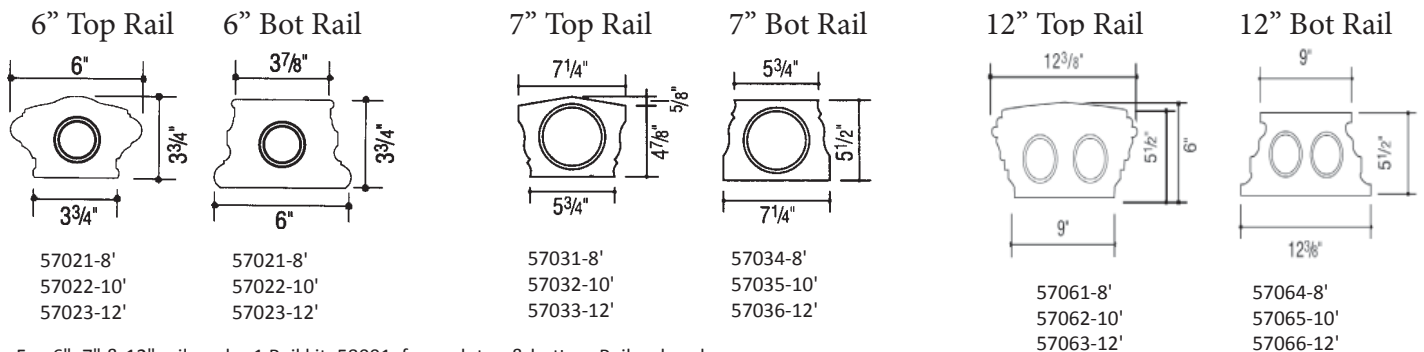
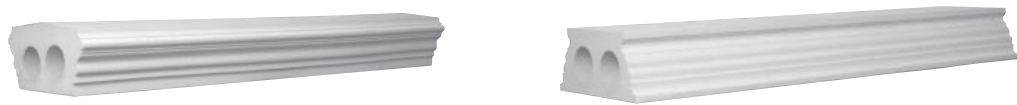

For, 6", 7" & 12" rails order 1 Rail kit, 58001, for each top & bottom Rail ordered.

B&B Wood Products inc.

Round Wood Columns - Paint Grade Exterior

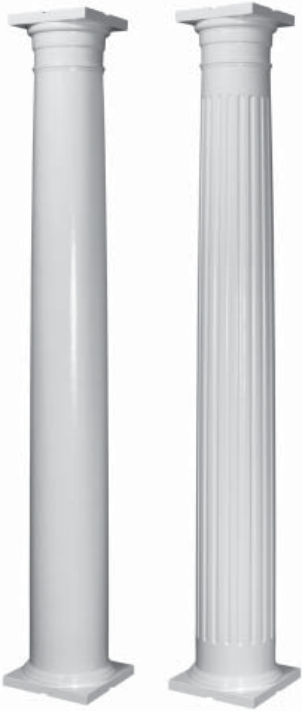

Shafts are paint grade and manufactured from solid staves with finger-joint and/or edge gluing. Caps & bases are polyurethane (wood as an option with no warranty)

Limited One year warranty if installed per installation instructions. See store.bbwood.com

Fluting begins about 4-1/2" below the neckmold, and ends approximately 8" above the base. Custom fluting is available.

Structural Load		Inside Dimension	
Diam	Lbs.	At Bottom	At Top
6	2000	3-1/8"	1-3/4"
8	3200	4-3/8"	3-1/2"
10	4200	6-3/4"	5-1/2"
12	5100	9-3/8"	7-1/8"

Caps & Bases for Wood Round Columns

Standard caps and bases are polyurethane. Wood caps and bases are available but column warranty is void. Aluminum plinths should be used with wood bases.



Poly Standard Base



Attic Poly Base

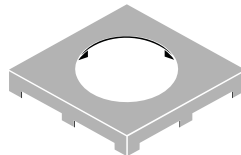

Aluminum Plinth

Cap and Base Specifications

	Poly Std		Poly Attic	
	Width @ base	Height of Base	Width @ base	Height of Base
6	7-1/4	3-3/16	-	-
8	9-1/4	3-1/4	10-1/4	5-1/8
10	11-1/4	3-1/4	13	6-1/2
12	13-1/8	3-1/4	16	7-1/2

Ornamental Urethane Caps



Greek Ionic
9E



Roman Ionic
store.bbwood.com



Scamozzi
216-292-6555



Roman Corinthian
sales@bbwood.com



Temple of the Winds

B&B Wood Products inc.

Wood Porch Posts

Posts are FJ laminated & require use of Aluminum Plinths or Quick Mount fasteners. Wood posts may be primed at manufacturer's option.

Custom Porch Posts

more on store.bbwood.com

Load Data		8'	9'	10'	Net widths
Wood #100	4"	3000	3000	3000	3-1/4"
	5"	6000	6000	6000	4-1/4"
	6"	7500	7500	7500	5-1/4"

Specifications:	Head	Turning	Base
#100 Wood	-8'	12"	40"
	-9'	24"	40"
	-10'	24"	40"

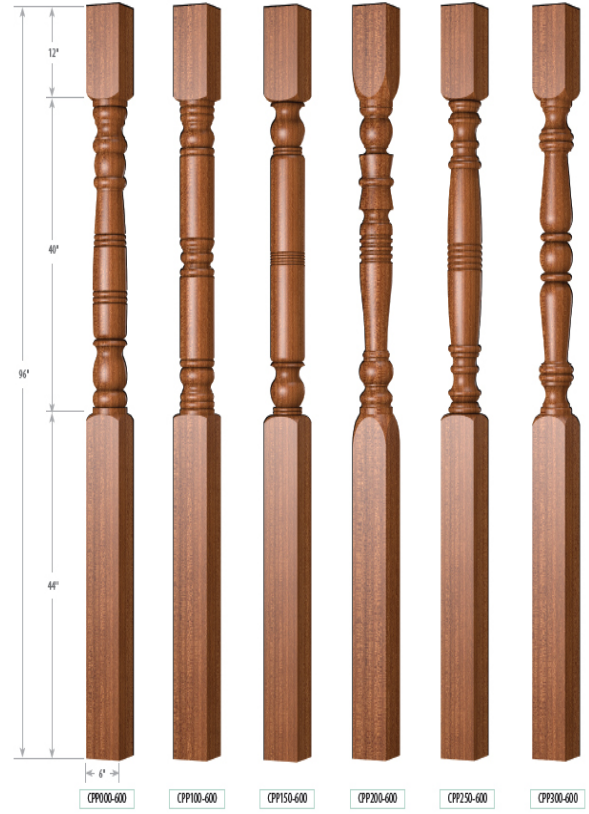
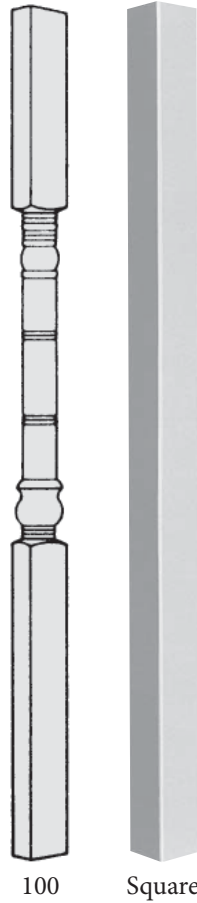

Quick Mount & Aluminum Plinths

An aluminum plinth (fasteners not included) or a Quick-Mount Fastener should be used on all wood porch posts.

The Aluminum Plinth is a quick and easy way to ensure that your posts are installed correctly. The plinth protects the post from moisture and connects it to the structure.

The Quick-Mount™ Porch Post Fasteners provide a ventilating moisture barrier between the post and ground. They prevent water damage and increase the life of the post by many years. They can be installed directly into wood or concrete and they securely fasten the post in seconds. Please note that this item is not suitable for applications where special anti-uplift requirements apply.

Aluminum Plinths	Item
4" (3-1/4" wide)	1070
5" (4-1/4" wide)	1080
6" (5-1/4" wide)	1090
Quick-Mount	
4"	17004
5"	17005
6"	17006

Aluminum Plinth



Quick-Mount

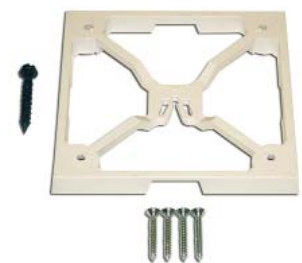

More Custom Porch Posts



Victorian Gingerbread

Exterior use of these products requires proper sealing, painting or staining.

SPINDLE FAN BRACKET - Unfinished in Alder, Cherry, Maple, Red Oak, and Rubberwood



BKT171091
1-1/2" x 8-1/2"H x 6"



BKT171079
1-1/2" x 12" sq.



BKT171085
1-1/2" x 7" sq.

SPANDREL

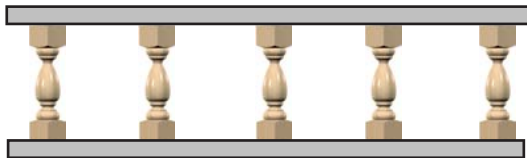

9" H

CS spindles are treated Hemlock. Top/bottom rail are PVC

CS-48 (48"W x 9"H x 2-5/8")

CS-72 (72"W x 9"H x 2-5/8") [longer lengths available]

Spindles 6" on center

SCREEN DOOR TRIM - Wood

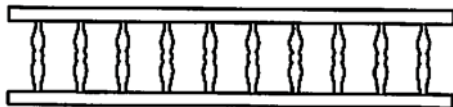

SD-35 1/2" x 34"W x 7-1/8"H

SD-34 1/2" x 34"W x 4"H - Subject to Stock

	Depth x Width x Height
CS-48	2-5/8" X 48" X 9"
CS-72	2-5/8" X 72" X 9"
BKT171091	1-1/2" x 8-1/2"H x 6"
BKT171079	1--1/2" x 12" sq.
BKT171085	1-1/2" x 7" sq.
SD-6	1/2" X 5-1/2" X 5-1/2"
SD-7	1/2" X 6-1/2" X 7"
SD-8	1/2" X 7-3/4" X 7-3/4"
SD-10	1/2" X 6-1/4" X 6-1/4"
SD-34	1/2" X 34" X 4"
SD-35	1/2" X 34" X 7-1/2"



SD-8
1/2" x 7-3/4" x 7-3/4"



SD-7
1/2" x 6-1/2" x 7"H



SD-6
1/2" x 5-1/2" x 5-1/2"



SD-10
1/2" x 6-1/4" x 6-1/4"

Note: the CS spandrel must be secured to the soffit or header to prevent sagging.

B&B Wood Products inc.

Distributed By:



\$2 Catalog List Price

© B&B Wood Products, Inc 2018 All rights reserved